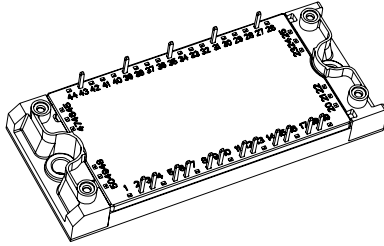

IGBT Sixpack Module, 50 A

ECONO2 6PACK

FEATURES

- Low diode V_F
- 10 μ s short circuit capability
- Square RBSOA
- Low $V_{CE(on)}$ non punch through IGBT technology
- HEXFRED® antiparallel diode with ultrasoft reverse recovery characteristics
- Positive $V_{CE(on)}$ temperature coefficient
- Ceramic DBC substrate
- Speed 8 to 60 kHz
- Totally lead (Pb)-free
- Designed and qualified for industrial market

RoHS
COMPLIANT

PRODUCT SUMMARY

V_{CES}	1200 V
$V_{CE(on)}$ (typical)	2.45 V
t_{sc} at $T_J = 150\text{ }^\circ\text{C}$	> 10 μ s
I_C at $T_C = 80\text{ }^\circ\text{C}$	50 A

BENEFITS

- Benchmark efficiency for motor control
- Rugged transient performance
- Low EMI, requires less snubbing
- Direct mounting to heatsink
- PCB solderable terminals
- Low junction to case thermal resistance
- UL approved E78996

ABSOLUTE MAXIMUM RATINGS

PARAMETER	SYMBOL	TEST CONDITIONS	MAX.	UNITS
Collector to emitter voltage	V_{CES}		1200	V
Continuous collector current	I_C	$T_C = 25\text{ }^\circ\text{C}$	75	A
		$T_C = 80\text{ }^\circ\text{C}$	50	
Pulsed collector current See fig. C.T.5	I_{CM}		150	
Clamped inductive load current	I_{LM}		150	
Diode continuous forward current	I_F	$T_C = 25\text{ }^\circ\text{C}$	75	
		$T_C = 80\text{ }^\circ\text{C}$	50	
Pulsed diode maximum forward current	I_{FM}		150	
Gate to emitter voltage	V_{GE}		± 20	V
Maximum power dissipation (IGBT and DIODE)	P_D	$T_C = 25\text{ }^\circ\text{C}$	329	W
		$T_C = 80\text{ }^\circ\text{C}$	184	
Maximum operating junction temperature	T_J		150	$^\circ\text{C}$
Storage temperature range	T_{Stg}		- 40 to + 125	
Isolation voltage	V_{ISOL}		AC 2500 (minimum)	V



ELECTRICAL SPECIFICATIONS ($T_J = 25\text{ }^\circ\text{C}$ unless otherwise specified)						
PARAMETER	SYMBOL	TEST CONDITIONS	MIN.	TYP.	MAX.	UNITS
Collector to emitter breakdown voltage	$BV_{(CES)}$	$V_{GE} = 0\text{ V}, I_C = 500\text{ }\mu\text{A}$	1200	-	-	V
Temperature coefficient of breakdown voltage	$\Delta V_{(BR)CES}/\Delta T_J$	$V_{GE} = 0\text{ V}, I_C = 1\text{ mA}$ (25 °C to 125 °C)	-	0.31	-	V/°C
Collector to emitter voltage	$V_{CE(ON)}$	$I_C = 50\text{ A}, V_{GE} = 15\text{ V}$	-	2.45	2.65	V
		$I_C = 75\text{ A}, V_{GE} = 15\text{ V}$	-	2.85	3.15	
		$I_C = 50\text{ A}, V_{GE} = 15\text{ V}, T_J = 125\text{ }^\circ\text{C}$	-	2.85	-	
		$I_C = 75\text{ A}, V_{GE} = 15\text{ V}, T_J = 125\text{ }^\circ\text{C}$	-	3.45	-	
Gate threshold voltage	$V_{GE(th)}$	$V_{CE} = V_{GE}, I_C = 250\text{ }\mu\text{A}$	4.0	4.9	6.0	
Threshold voltage temperature coefficient	$\Delta V_{GE(th)}/\Delta T_J$	$V_{CE} = V_{GE}, I_C = 1\text{ mA}$ (25 °C to 125 °C)	-	- 12	-	mV/°C
Zero gate voltage collector current	I_{CES}	$V_{GE} = 0\text{ V}, V_{CE} = 1200\text{ V}$	-	-	100	μA
		$V_{GE} = 0\text{ V}, V_{CE} = 1200\text{ V}, T_J = 125\text{ }^\circ\text{C}$	-	1000	-	
Diode forward voltage drop	V_{FM}	$I_F = 50\text{ A}$	-	1.95	2.25	V
		$I_F = 75\text{ A}$	-	2.20	2.60	
		$I_F = 50\text{ A}, T_J = 125\text{ }^\circ\text{C}$	-	2.05	-	
		$I_F = 75\text{ A}, T_J = 125\text{ }^\circ\text{C}$	-	2.40	-	
Gate to emitter leakage current	I_{GES}	$V_{GE} = \pm 20\text{ V}$	-	-	± 200	nA

SWITCHING CHARACTERISTICS ($T_J = 25\text{ }^\circ\text{C}$ unless otherwise specified)						
PARAMETER	SYMBOL	TEST CONDITIONS	MIN.	TYP.	MAX.	UNITS
Total gate charge (turn-on)	Q_G	$I_C = 50\text{ A}$	-	355	535	nC
Gate to emitter charge (turn-on)	Q_{GE}	$V_{CC} = 600\text{ V}$	-	35	55	
Gate to collector charge (turn-on)	Q_{GC}	$V_{GE} = 15\text{ V}$	-	165	250	
Turn-on switching loss	E_{on}	$I_C = 50\text{ A}, V_{CC} = 600\text{ V}$	-	3.60	4.64	mJ
Turn-off switching loss	E_{off}	$V_{GE} = 15\text{ V}, R_G = 10\text{ }\Omega, L = 400\text{ }\mu\text{H}$	-	3.74	4.78	
Total switching loss	E_{tot}	$T_J = 25\text{ }^\circ\text{C}$ ⁽¹⁾	-	7.34	9.42	
Turn-on switching loss	E_{on}	$I_C = 50\text{ A}, V_{CC} = 600\text{ V}$	-	5.05	7.10	
Turn-off switching loss	E_{off}	$V_{GE} = 15\text{ V}, R_G = 10\text{ }\Omega, L = 400\text{ }\mu\text{H}$	-	5.53	7.75	
Total switching loss	E_{tot}	$T_J = 125\text{ }^\circ\text{C}$ ⁽¹⁾	-	10.58	14.85	
Turn-on delay time	$t_{d(ON)}$	$I_C = 50\text{ A}, V_{CC} = 600\text{ V}$ $V_{GE} = 15\text{ V}, R_G = 10\text{ }\Omega, L = 400\text{ }\mu\text{H}$ $T_J = 125\text{ }^\circ\text{C}$	-	60	80	ns
Rise time	t_r		-	40	60	
Turn-off delay time	$t_{d(OFF)}$		-	570	665	
Fall time	t_f		-	205	270	
Input capacitance	C_{ies}	$V_{GE} = 0\text{ V}$	-	4945	-	pF
Output capacitance	C_{oes}	$V_{CC} = 30\text{ V}$	-	885	-	
Reverse transfer capacitance	C_{res}	$f = 1\text{ MHz}$	-	100	-	
Reverse bias safe operating area	RBSOA	$T_J = 150\text{ }^\circ\text{C}, I_C = 150\text{ A}$ $R_G = 10\text{ }\Omega, V_{GE} = 15\text{ V to } 0\text{ V}$	Fullsquare			
Short circuit safe operating area	SCSOA	$T_J = 150\text{ }^\circ\text{C}$ $V_{CC} = 900\text{ V}, V_P = 1200\text{ V}$ $R_G = 10\text{ }\Omega, V_{GE} = 15\text{ V to } 0\text{ V}$	10	-	-	μs
Diode peak reverse recovery current	I_{rr}	$T_J = 125\text{ }^\circ\text{C}$ $V_{CC} = 600\text{ V}, I_F = 50\text{ A}, L = 400\text{ }\mu\text{H}$ $V_{GE} = 15\text{ V}, R_G = 10\text{ }\Omega$	-	87	-	A

Note

(1) Energy losses include "tail" and diode reverse recovery



THERMAL AND MECHANICAL SPECIFICATIONS					
PARAMETER	SYMBOL	MIN.	TYP.	MAX.	UNITS
Junction to case IGBT	R _{thJC}	-	-	0.38	°C/W
Junction to case DIODE		-	-	0.70	
Case to sink, flat, greased surface	R _{thCS}	-	0.05	-	
Mounting torque (M5)		2.7	-	3.3	Nm
Weight		-	170	-	g

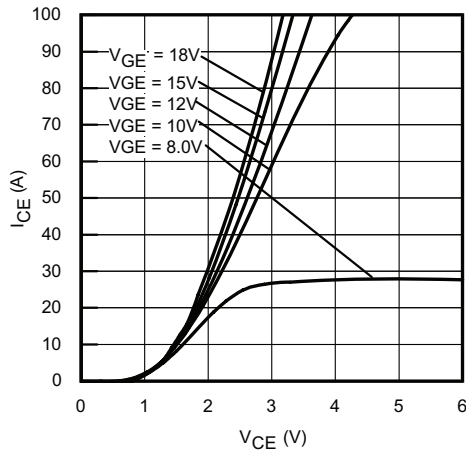

Fig. 1 - Typical IGBT Output Characteristics
T_J = 25 °C; t_p = 80 μs

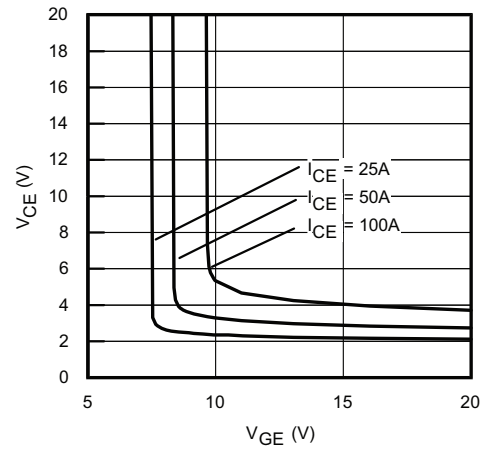

Fig. 3 - Typical V_{CE} vs. V_{GE}
T_J = 25 °C

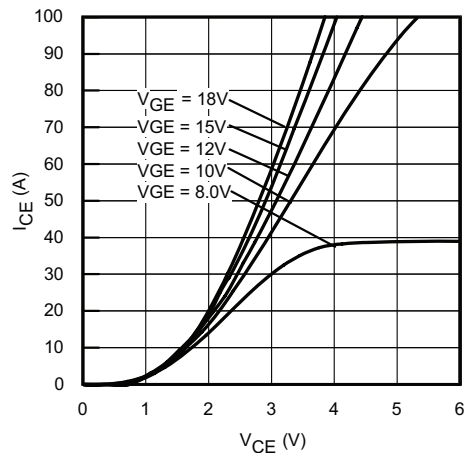

Fig. 2 - Typical IGBT Output Characteristics
T_J = 125 °C, t_p = 80 μs

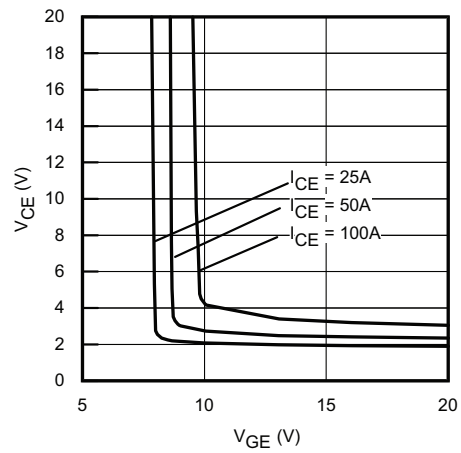

Fig. 4 - Typical V_{CE} vs. V_{GE}
T_J = 125 °C

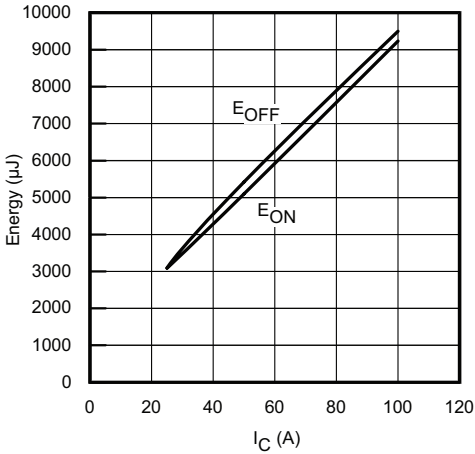

Fig. 5 - Typical Energy Loss vs. I_C
 $T_J = 125\text{ }^\circ\text{C}$; $L = 400\text{ }\mu\text{H}$; $V_{CE} = 600\text{ V}$
 $R_G = 10\text{ }\Omega$; $V_{GE} = 15\text{ V}$

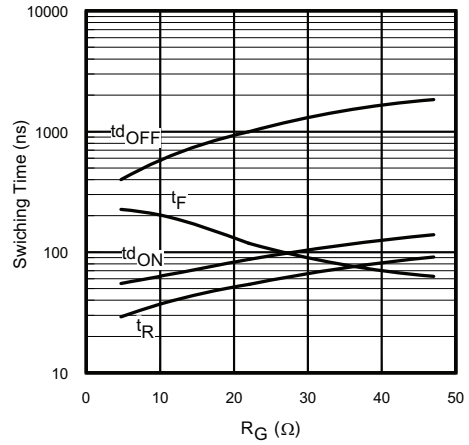

Fig. 8 - Typical Switching Time vs. R_G
 $T_J = 125\text{ }^\circ\text{C}$; $L = 400\text{ }\mu\text{H}$; $V_{CE} = 600\text{ V}$
 $I_{CE} = 50\text{ A}$; $V_{GE} = 15\text{ V}$

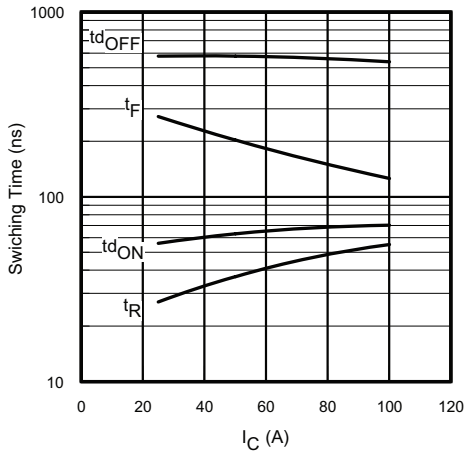

Fig. 6 - Typical Switching Time vs. I_C
 $T_J = 125\text{ }^\circ\text{C}$; $L = 400\text{ }\mu\text{H}$; $V_{CE} = 600\text{ V}$
 $R_G = 10\text{ }\Omega$; $V_{GE} = 15\text{ V}$

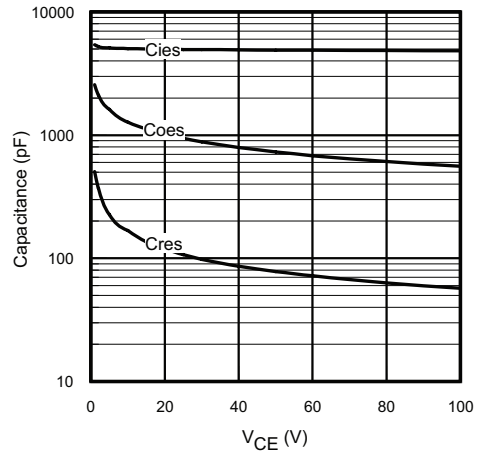

Fig. 9 - Typical Capacitance vs. V_{CE}
 $V_{GE} = 0\text{ V}$; $f = 1\text{ MHz}$

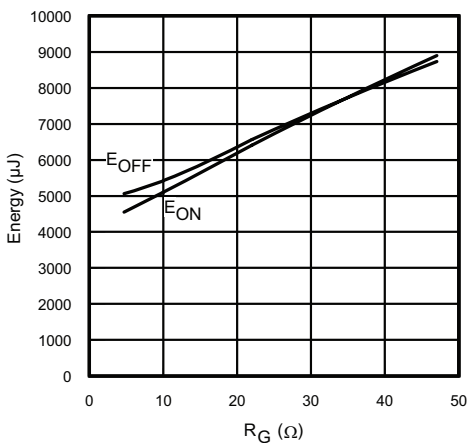

Fig. 7 - Typical Energy Loss vs. R_G
 $T_J = 125\text{ }^\circ\text{C}$; $L = 400\text{ }\mu\text{H}$; $V_{CE} = 600\text{ V}$
 $I_{CE} = 50\text{ A}$; $V_{GE} = 15\text{ V}$

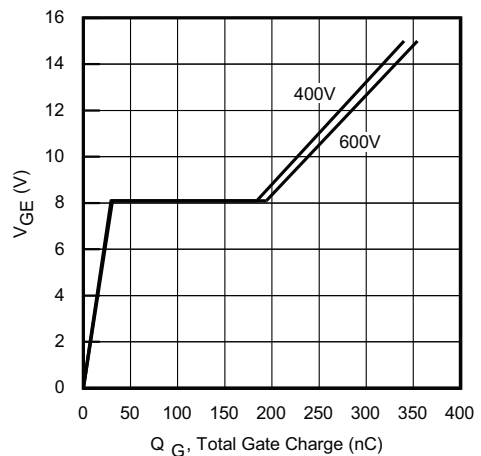

Fig. 10 - Typical Gate Charge vs. V_{GE}
 $I_{CE} = 50\text{ A}$; $L = 600\text{ }\mu\text{H}$

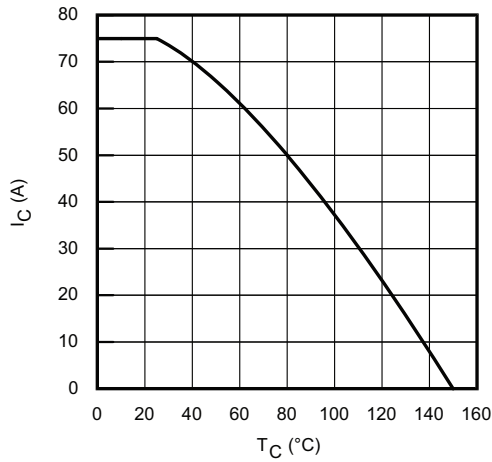

Fig. 11 - Maximum DC Collector Current vs. Case Temperature

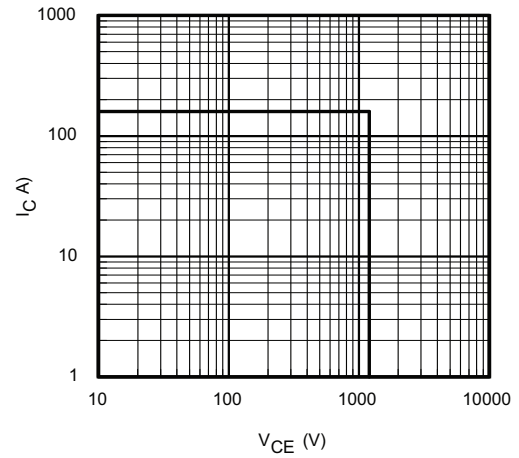
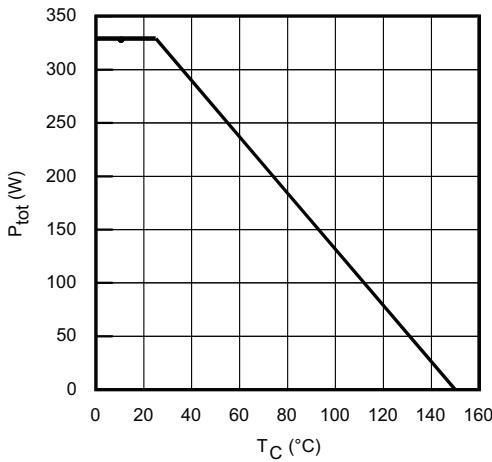
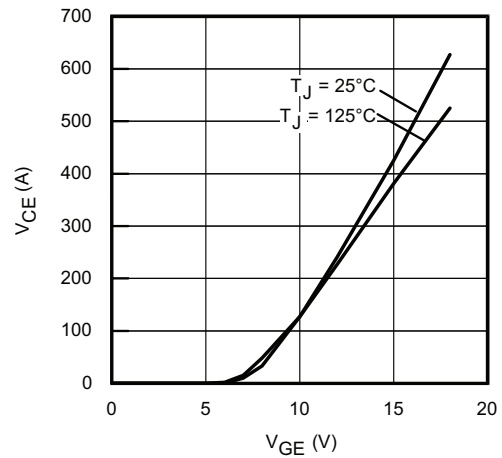
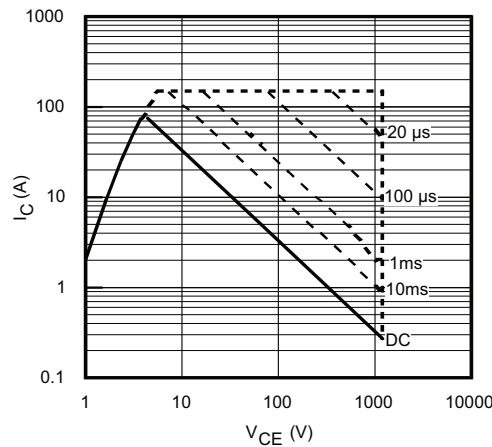
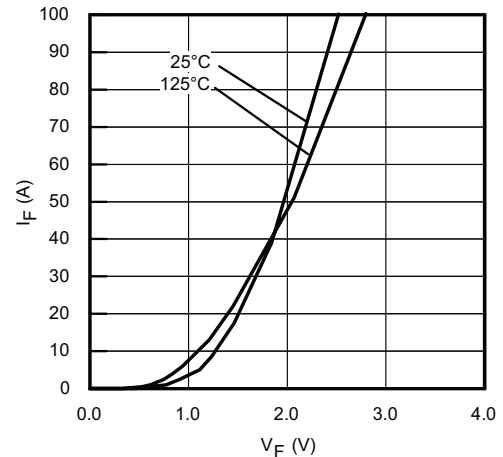

 Fig. 14 - Reverse Bias SOA
 $T_J = 150\text{ }^\circ\text{C}$; $V_{GE} = 15\text{ V}$

Fig. 12 - Power Dissipation vs. Case Temperature

 Fig. 15 - Typical Transfer Characteristics
 $V_{CE} = 50\text{ V}$; $t_p = 10\text{ }\mu\text{s}$

 Fig. 13 - Forward SOA
 $T_C = 25\text{ }^\circ\text{C}$; $T_J \leq 150\text{ }^\circ\text{C}$

 Fig. 16 - Typical Diode Forward Characteristics
 $t_p = 80\text{ }\mu\text{s}$

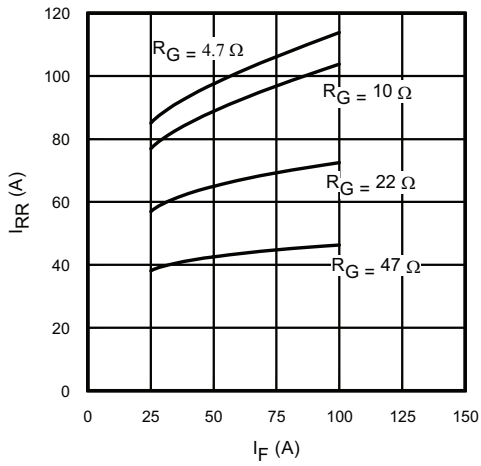

Fig. 17 - Typical Diode I_{RR} vs. I_F
 $T_J = 125^\circ\text{C}$

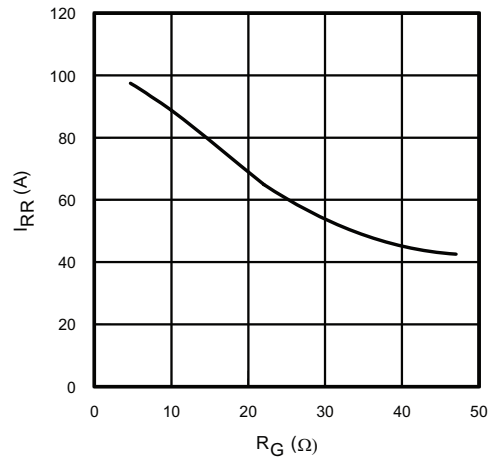

Fig. 18 - Typical Diode I_{RR} vs. R_G
 $T_J = 125^\circ\text{C}$; $I_F = 50\text{ A}$

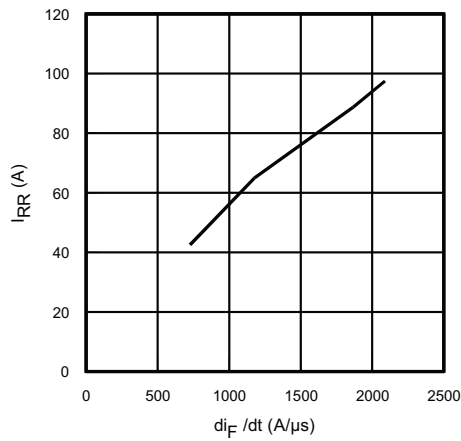

Fig. 19 - Typical Diode I_{RR} vs. dI_F/dt ; $V_{CC} = 600\text{ V}$;
 $V_{GE} = 15\text{ V}$; $I_{CE} = 50\text{ A}$; $T_J = 125^\circ\text{C}$

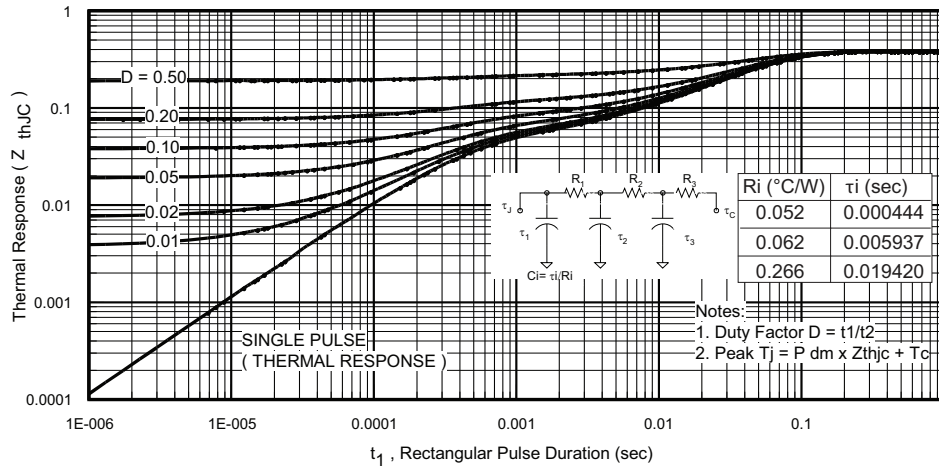

Fig. 20 - Maximum Transient Thermal Impedance, Junction to Case (IGBT)

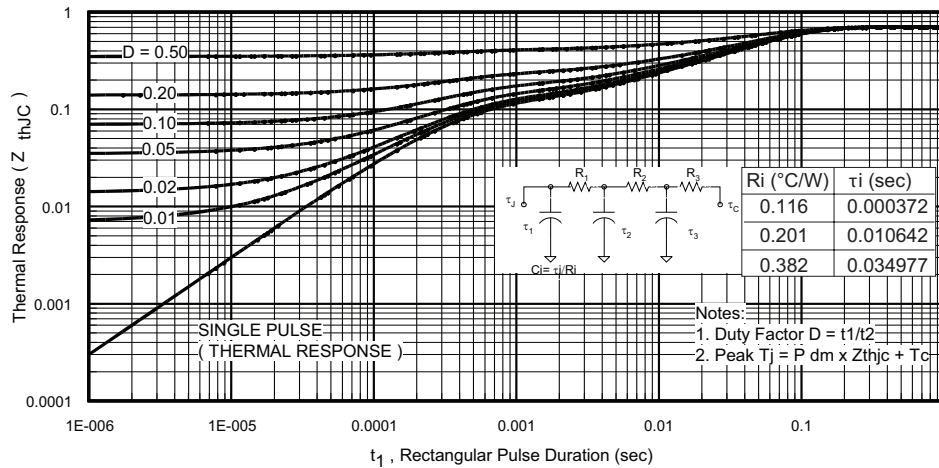

Fig. 21 - Maximum Transient Thermal Impedance, Junction to Case (DIODE)

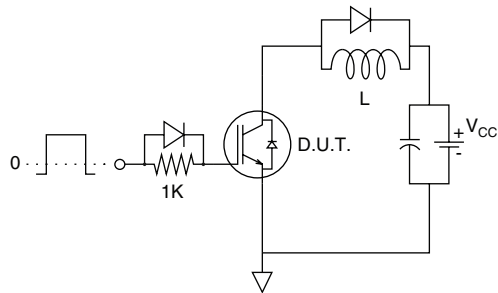

Fig. C.T.1 - Gate Charge Circuit (Turn-Off)

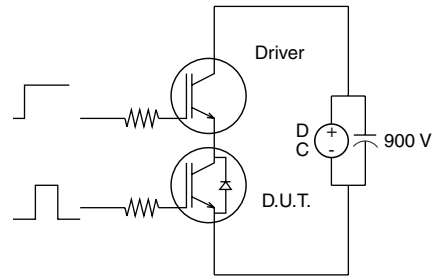

Fig. C.T.3 - S.C. SOA Circuit

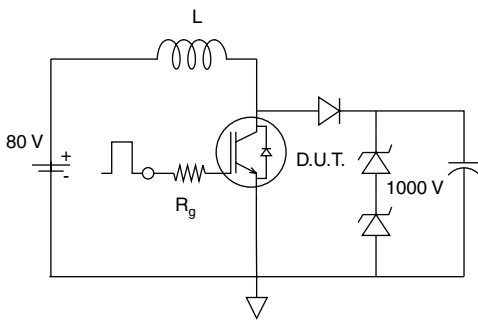

Fig. C.T.2 - RBSOA Circuit

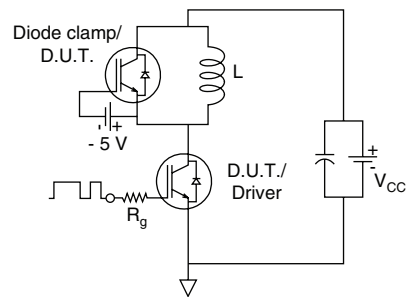

Fig. C.T.4 - Switching Loss Circuit

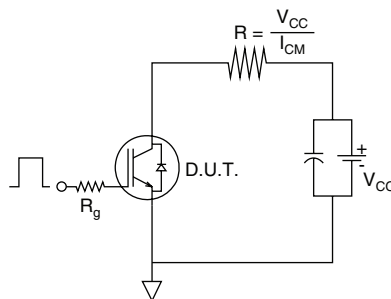

Fig. C.T.5 - Resistive Load Circuit

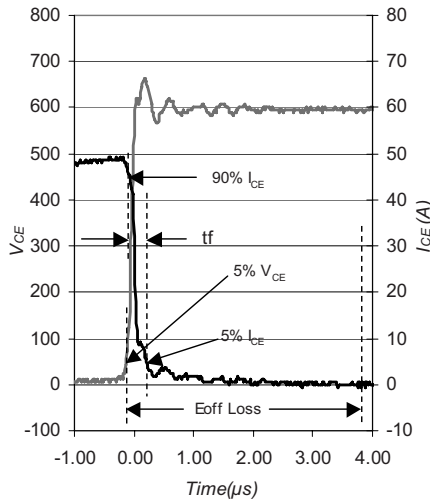

Fig. WF1 - Typical Turn-Off Loss Waveform
at $T_J = 125^\circ\text{C}$ using Fig. C.T.4

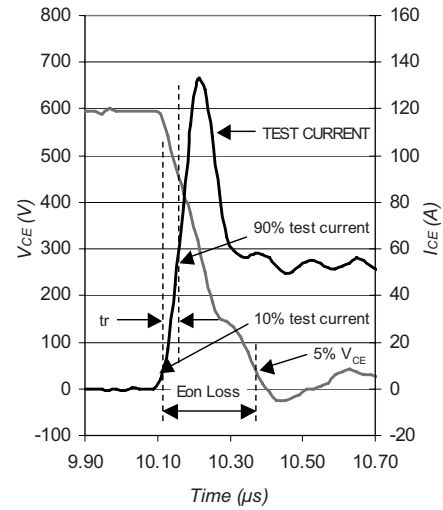
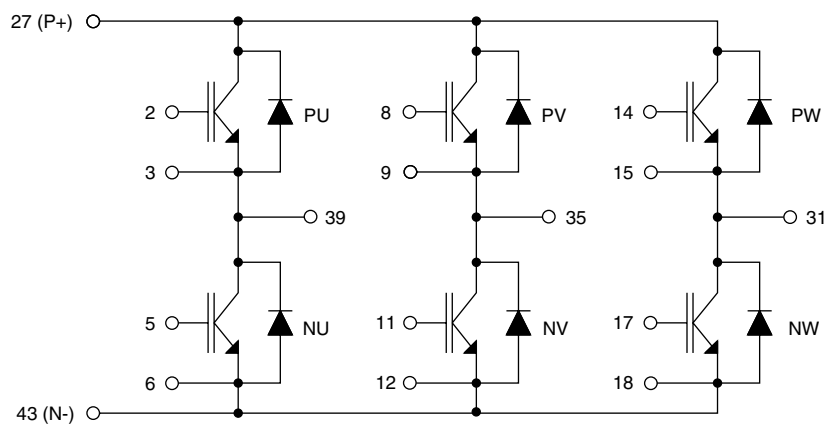

Fig. WF2 - Typical Turn-On Loss Waveform
at $T_J = 125^\circ\text{C}$ using Fig. C.T.4

ORDERING INFORMATION TABLE

Device code	G	B	50	X	F	120	K
	①	②	③	④	⑤	⑥	⑦
	1	2	3	4	5	6	7
	1 - Insulated Gate Bipolar Transistor (IGBT) 2 - IGBT Generation 5 NPT 3 - Current rating (50 = 50 A) 4 - Circuit configuration (X = Sixpack or three phase inverter) 5 - Package (F = ECONO2) 6 - Voltage rating (120 = 1200 V) 7 - Ultrafast (Speed 8 to 60 kHz)						

CIRCUIT CONFIGURATION



LINKS TO RELATED DOCUMENTS

LINKS TO RELATED DOCUMENTS	
Dimensions	http://www.vishay.com/doc?95089
Part marking information	http://www.vishay.com/doc?95090



Disclaimer

All product specifications and data are subject to change without notice.

Vishay Intertechnology, Inc., its affiliates, agents, and employees, and all persons acting on its or their behalf (collectively, "Vishay"), disclaim any and all liability for any errors, inaccuracies or incompleteness contained herein or in any other disclosure relating to any product.

Vishay disclaims any and all liability arising out of the use or application of any product described herein or of any information provided herein to the maximum extent permitted by law. The product specifications do not expand or otherwise modify Vishay's terms and conditions of purchase, including but not limited to the warranty expressed therein, which apply to these products.

No license, express or implied, by estoppel or otherwise, to any intellectual property rights is granted by this document or by any conduct of Vishay.

The products shown herein are not designed for use in medical, life-saving, or life-sustaining applications unless otherwise expressly indicated. Customers using or selling Vishay products not expressly indicated for use in such applications do so entirely at their own risk and agree to fully indemnify Vishay for any damages arising or resulting from such use or sale. Please contact authorized Vishay personnel to obtain written terms and conditions regarding products designed for such applications.

Product names and markings noted herein may be trademarks of their respective owners.